



# HYDRA 4FT PUCK HOCKEY TABLE



IF YOUR TABLE HAS DAMAGES, MISSING PARTS OR YOU ARE NOT **100% SATISFIED** PLEASE **CONTACT PUCK NOT THE RESELLER.**

FOR THE MOST CURRENT INSTRUCTION MANUALS AND ASSEMBLY VIDEOS, PLEASE VISIT OUR WEBSITE OR CONTACT **PUCK.**

**CONTACT INFORMATION:**

**Email:** [support@puckhockeytables.com](mailto:support@puckhockeytables.com)  
**Website:** [www.puckhockeytables.com](http://www.puckhockeytables.com)  
**Phone:** 1-844-781-7825

**MAILING ADDRESS:**

PUCK Hockey Tables  
2186 Jackson Keller Rd, Ste 1095  
San Antonio, Texas 78213

# THANK YOU!

**Thank you for purchasing this product.** We work around the clock and around the globe to ensure that our products maintain the highest possible quality. However, in the rare case of issues during assembly or use of this product. Please contact our consumer hotline at **1-866-334-7225** for immediate assistance. Please read the warranty information at the back of these assembly Instructions for further details.

## ASSEMBLY TIPS

### **IMPORTANT! PLEASE READ THESE ASSEMBLY INSTRUCTIONS IN ENTIRETY BEFORE ASSEMBLING YOUR PRODUCT.**

1. Find a clean, level surface to begin the assembly of your game table. We recommend that two adults work together to assemble this game. You may want to carefully cut or tear the four corners of the box so that the bottom of the box can be used as your work surface.
2. Remove all of the contents from box and verify that you have all of the parts shown on the Parts List before you begin assembly. **Note: Some parts may be pre-installed or pre-assembled.**
3. Some figures or drawings may not look exactly like product.
4. ***When installing parts that have more than one screw or bolt, hand tighten all screws or bolts in place before final tightening with screwdriver or wrench.***
5. Electric screwdrivers may be helpful during assembly; however, please set a **low torque** and use extreme caution because screws may be stripped or overtightened, resulting in damaged parts, if the electric screwdriver's torque is set too high.

### **WARNINGS!**







READ AND FOLLOW ALL ASSEMBLY, OPERATION AND SAFETY INSTRUCTIONS CAREFULLY.

**CHOKER HAZARD - THIS ITEM MAY CONTAIN SMALL BALLS AND PARTS  
NOT SUITABLE FOR CHILDREN UNDER 3 YEARS OF AGE.**

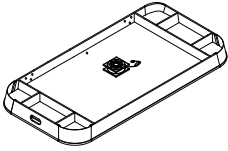
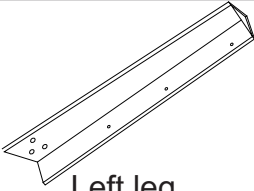
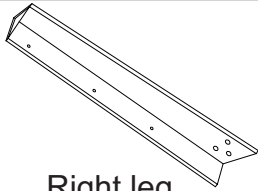
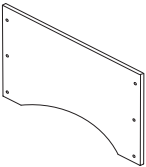
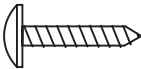
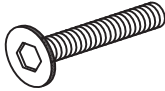
### **CARE AND USE**

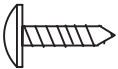
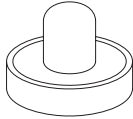
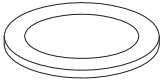
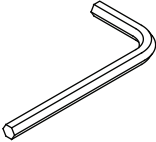
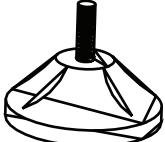
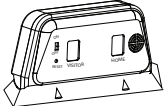
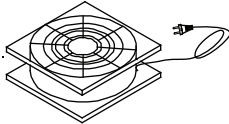
1. This product is intended for **INDOOR** use only.
2. Do **NOT** drag the table when moving it, as this will damage the legs.

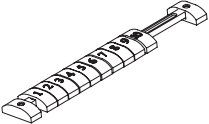
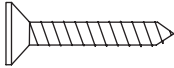
# PUCK HOCKEY TABLE - P401 PARTS LIST

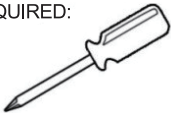
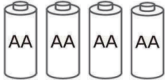
<p>#1</p>  <p>Main Cabinet 1 piece</p>	<p>#2</p>  <p>Left leg 2 pieces</p>	<p>#3</p>  <p>Right leg 2 pieces</p>
<p>#4</p>  <p>Leg end panel 2 pieces</p>	<p>#5</p>  <p>3/4 " Round head screw 4 pieces</p>	<p>#6</p>  <p>1/4 " x7/8 " Bolt 12 pieces</p>
<p>#7</p>  <p>1/4 " Washer 12pieces</p>	<p>#8</p>  <p>1/2 " Round head screw 12 pieces</p>	<p>#9</p>  <p>Hockey pusher 2 pieces</p>
<p>#10</p>  <p>Hockey puck 2 pieces</p>	<p>#11</p>  <p>Allen Key 1 piece</p>	<p>#12</p>  <p>Leg leveler 4 pieces</p>
<p>#13</p>  <p>Electronic Scorer 1 piece</p>	<p>#14</p>  <p>Motor (Pre-assembled) 1 piece</p>	<p>#15</p>  <p>Adaptor 1 piece</p>
<p>#16</p>  <p>Scorer 2 pieces</p>	<p>#17</p>  <p>1 " Flat head screw 4pieces</p>	<p>#18</p>  <p>Accessories carry bag 1 piece</p>
<p>ADDITIONAL EQUIPMENT REQUIRED:</p>  <p>PHILLIPS HEAD SCREWDRIVER</p>	<p>ADDITIONAL EQUIPMENT REQUIRED:</p>  <p>4 AA BATTERIES (NOT INCLUDED)</p>	

For replacement parts, please call 1-844-781-7825

## Assembly Tips:

**Attention:** If you are using an electric screwdriver in the assembly, please set at low torque and do not over tighten the hardware. When assembling individual parts, loosely tighten screws until all screws are inserted, then tighten completely.

## Assembly Instructions

**NOTE: We recommend that two adults work together to assemble this Hockey Table.**

### Step 1

Find a clean, level place to begin the assembly of your hockey table. The table will be assembled upside down and then turned over onto its legs once the assembly is completed.

### Step 2

Remove all the parts from the box and verify that you have all of the parts as shown on the parts list. Carefully cut or tear the four corners of the box so that the bottom of the box can be used as your work surface.

### Step 3

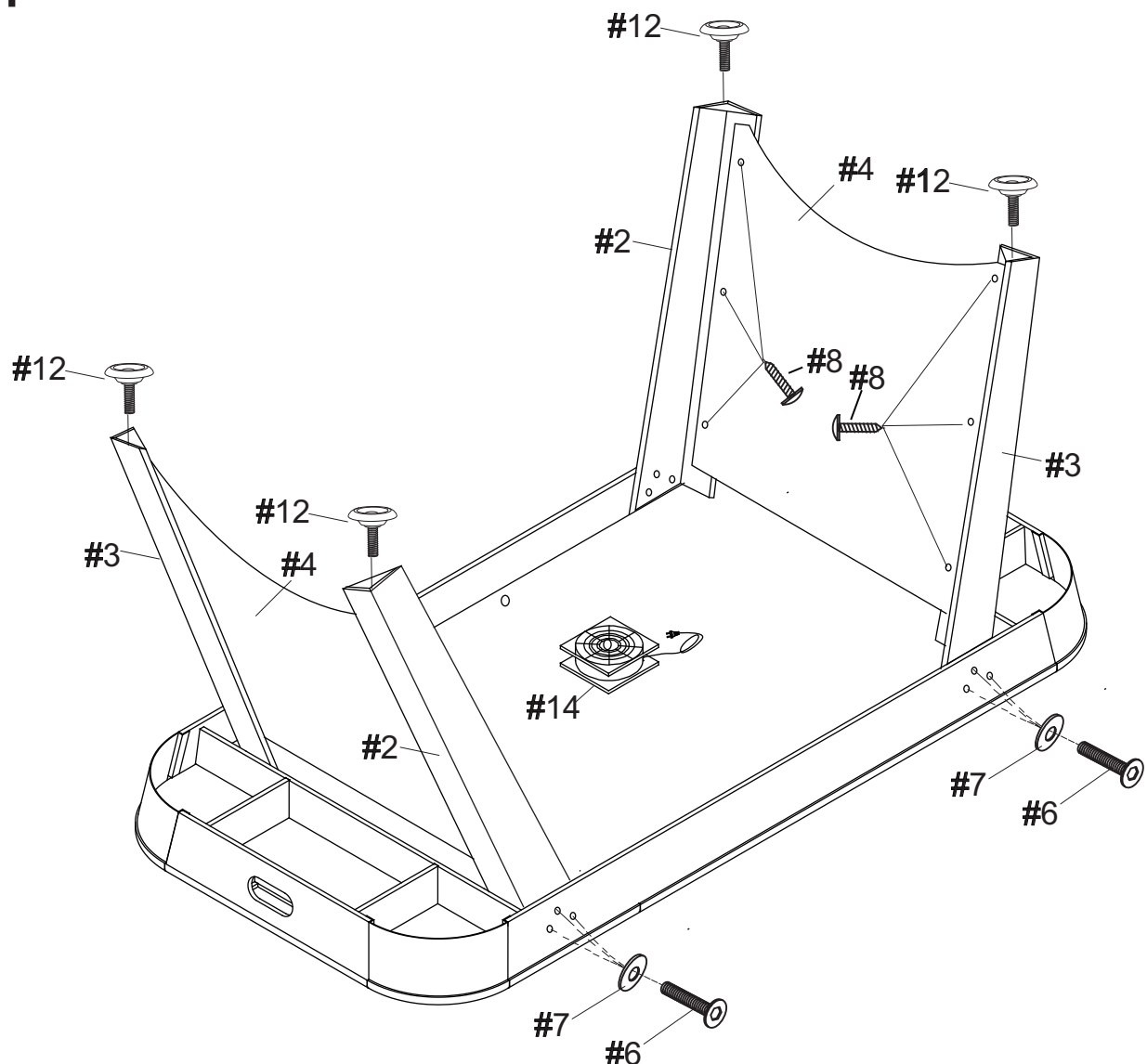

# Step 4

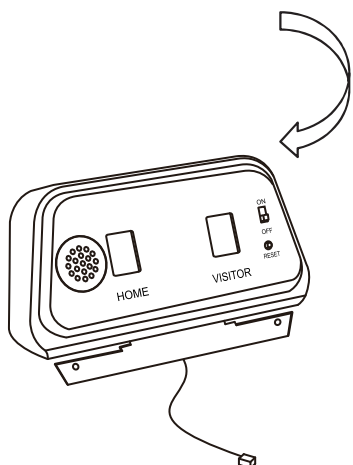
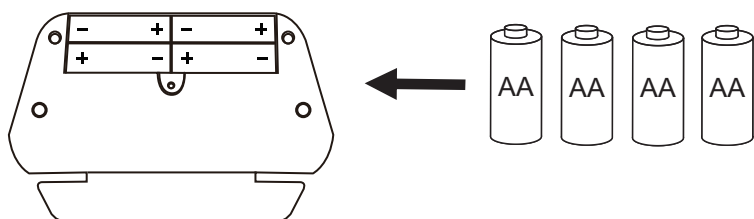
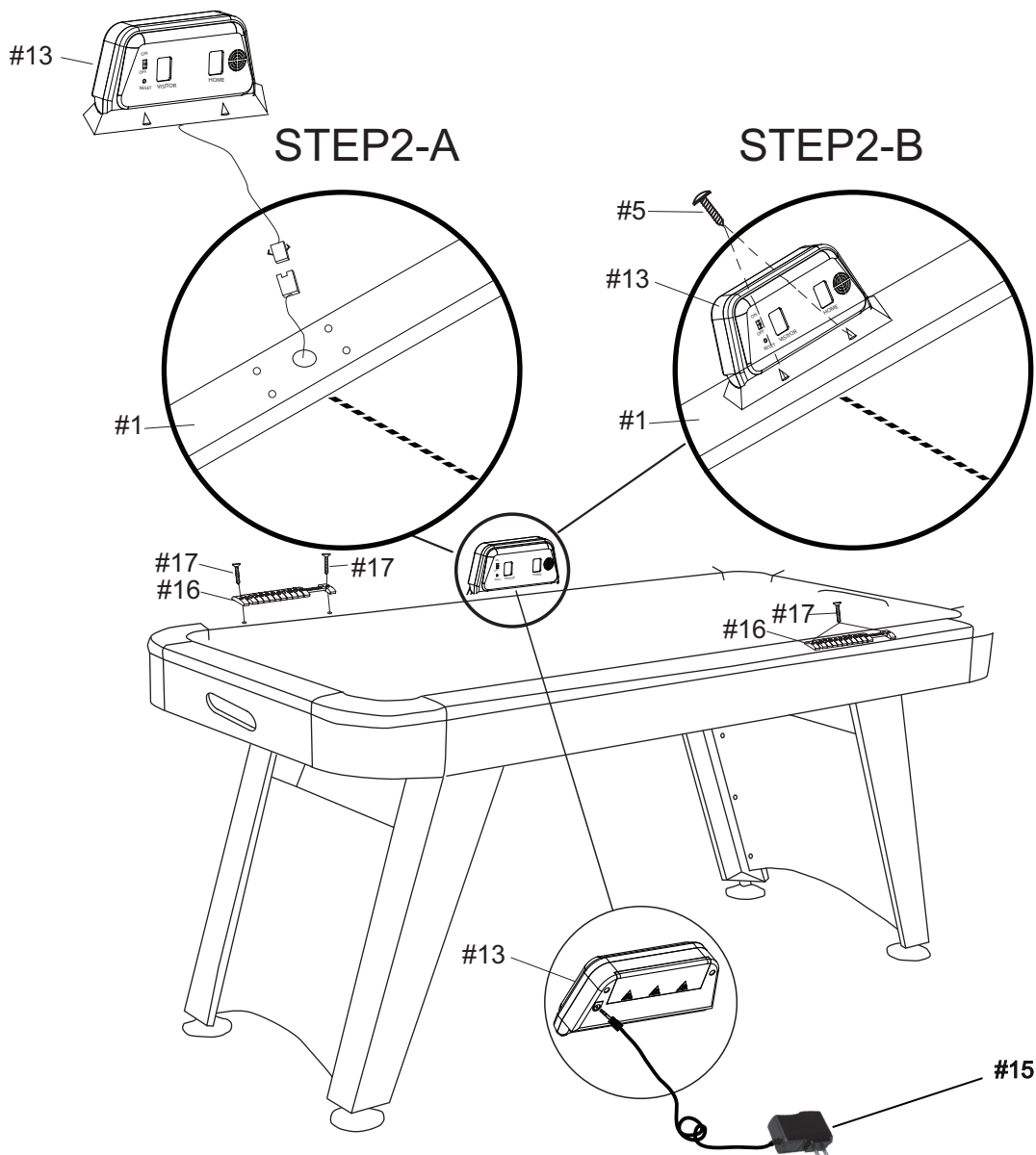

## WARNING!

DO NOT mix different types of batteries or new and old batteries.  
Non-rechargeable batteries are not to be recharged.  
Rechargeable batteries are to be removed before being charged.  
Exhausted batteries are to be removed from the game.  
Batteries are to be inserted with correct polarity.

## Step 6

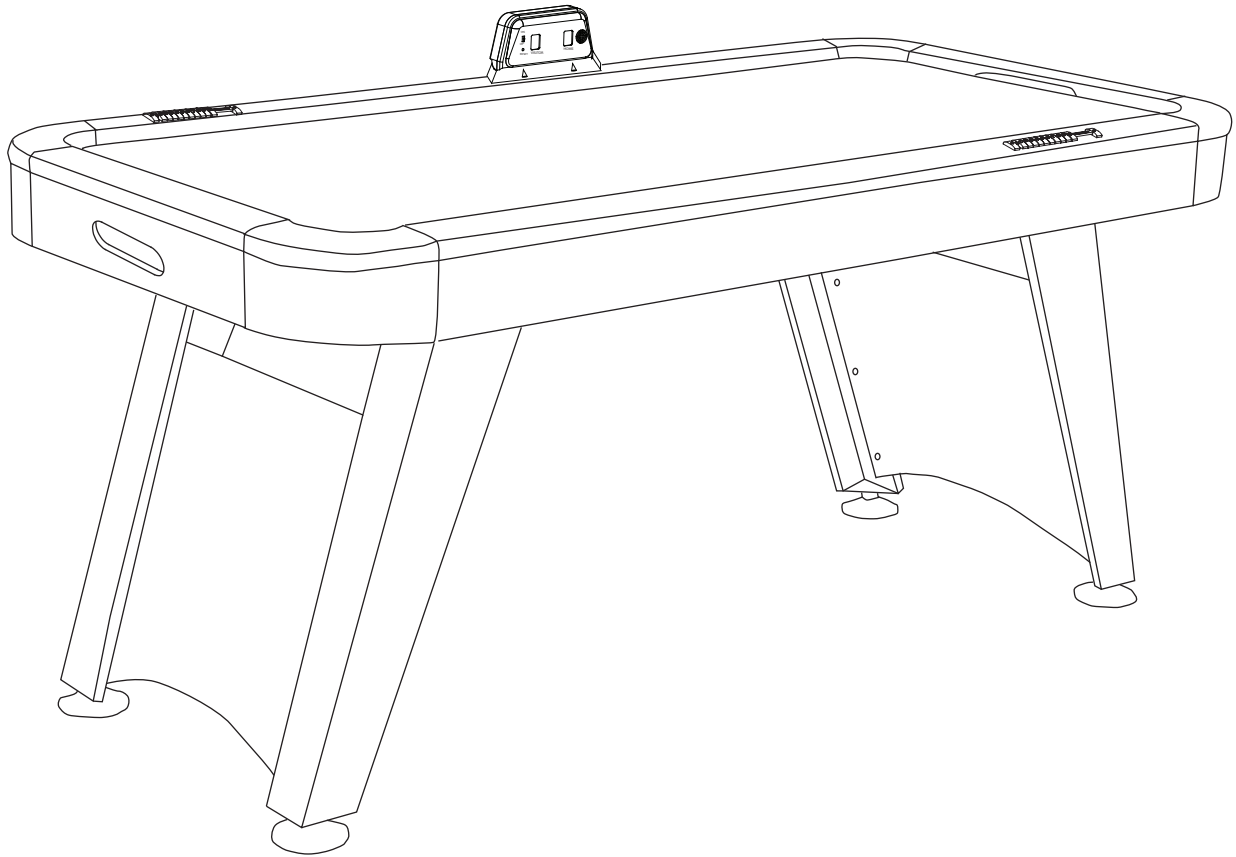

Congratulations! You have now assembled your hockey table. Please note the Care and Use instructions below to insure many years of trouble free use of your hockey table.

### **CARE AND USE OF YOUR TABLE**

1. Use only a slightly damp soft cloth to clean.
2. This product is intended for **INDOOR** use only.
3. **DO NOT** sit, climb or lean on the table.
4. **DO NOT** drag the table when moving it. This will damage the legs.
5. **DO NOT** set drinks on the table.
6. The table comes with a table cover which will both protect and help keep clean the entire top of the hockey table.
7. Use a carpenter's level to properly level table using the leg levelers.
8. Periodically check all bolts and screws for correct tightness.

# LIFETIME WARRANTY

This product is warranted to the original purchaser to be free from defects in material or workmanship for a period of lifetime from the date of the original retail purchase.

This warranty does not cover defects or damage due to improper installation, alteration, accident or any other event beyond the control of the manufacturer. Defects or damage resulting from misuse, abuse or negligence will void this warranty. This warranty does not cover scratching or damage that may result from normal usage.

This product is not intended for institutional or commercial use; the manufacturer does not assume any liability for such use. Institutional or commercial use will void this warranty.

This warranty is nontransferable and is expressly limited to the repair or replacement of the defective product. During the warranty period, the manufacturer shall repair or replace defective parts at no cost to the purchaser. Shipping charges and insurance are not covered and are the responsibility of the purchaser. Labor charges and related expenses for removal, installation or replacement of the product or components are not covered under this warranty.

The manufacturer reserves the right to make substitutions to warranty claims if parts are unavailable or obsolete.

The manufacturer shall not be liable for loss of use of the product or other consequential or incidental costs, expenses or damages incurred by the consumer of any other use. The user assumes all risk of injury resulting from the use of this product.

This warranty is expressly in lieu of all other warranties, expressed or implied, including warranties of merchantability or fitness for use to the extent permitted by Federal or state law. Neither the manufacturer nor any of its representatives assumes any other liability in connection with this product.

**All warranty claims must be made through the retailer where the product was originally purchased. A purchase receipt or other proof of date of purchase will be required to process all warranty claims. The model number and part numbers found within the assembly instructions will be required when submitting any parts requests or warranty claims.**

**For further warranty information or inquiries, please call 1-844-781-7825**